

# INTERIOR LAMPS

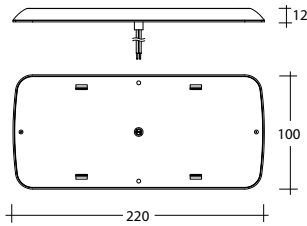

**INTERIOR ROOF AND RECREATIONAL VEHICLE LAMPS**  
**INTERIOR DOME LAMPS**  
**FLUORESCENT LAMPS**



**Part No./ Description**

**306822**  
**9-33 Volt Saturn Rectangular L.E.D Interior lamp**  
**with Touch Sensitive On/Dim/Off Switch**

Smooth yet powerful SMD L.E.Ds with a 'Dim' setting and an in-built touch sensitive switch. Ultra slim surface mount design maximises headroom for enclosed cabin areas

Current Draw: 0.26A at 12V, 0.14A at 24V

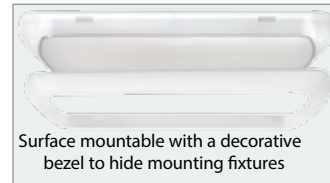

Surface mountable with a decorative bezel to hide mounting fixtures

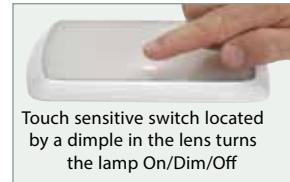
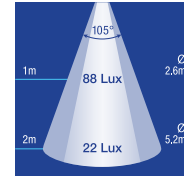

Touch sensitive switch located by a dimple in the lens turns the lamp On/Dim/Off

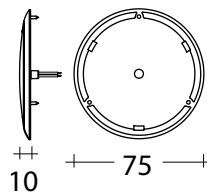

**Part No./ Description**

**306823**  
**9-33 Volt Saturn 75mm L.E.D Interior lamp**  
**with Touch Sensitive On/Dim/Off Switch**

Smooth yet powerful SMD L.E.Ds with a 'Dim' setting and an in-built touch sensitive switch. Ideal for surface mount downlighting, requiring only a 10mm hole for cable exit.

Current Draw: 0.04A at 12V, 0.02A at 24V



Touch sensitive switch located in the centre of the lens turns the lamp On/Dim/Off



Surface mountable with a decorative bezel to hide mounting fixtures

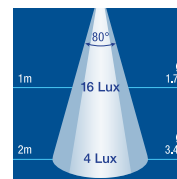

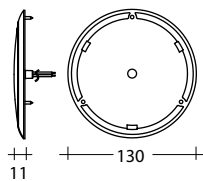

**Part No./ Description**

**306824**

**9-33 Volt Saturn 130mm L.E.D Interior lamp with Touch Sensitive On/Dim/Off Switch**

Smooth yet powerful SMD L.E.Ds with a 'Dim' setting and an in-built touch sensitive switch. Ultra slim surface mount design maximises headroom in enclosed cabin areas

Current Draw: 0.19A at 12V, 0.1A at 24V

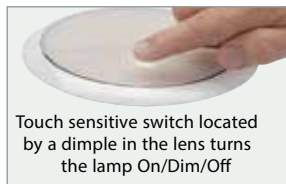

Touch sensitive switch located by a dimple in the lens turns the lamp On/Dim/Off



Surface mountable with a decorative

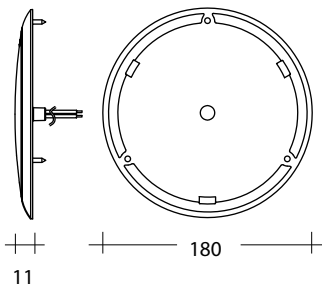
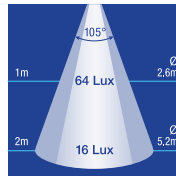

**Part No./ Description**

**306825**

**9 - 33 Volt Saturn 180mm L.E.D Interior lamp with touch sensitive On/dim/Off Switch**

Smooth yet powerful SMD L.E.Ds with a 'Dim' Setting and an in-built touch sensitive switch. the lamp is surface mountable and ideal for illuminating central and living areas.

Current Draw: 0.26A at 12V, 0.13A at 24V



Touch sensitive switch located by a dimple in the lens turns the lamp On/Dim/Off

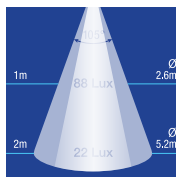

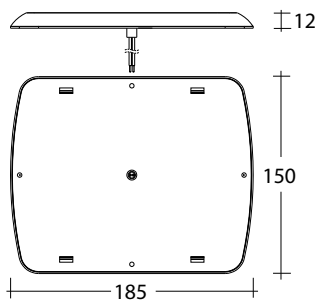

**Part No./ Description**

**306826**

**9-33 Volt Saturn L.E.D Interior Lamp with Touch Sensitive On/Dim/Off Switch**

Smooth yet powerful SMD L.E.Ds with a 'Dim' setting and an in-built touch sensitive switch. A large elegant lamp, surface mountable and ideal for illuminating central and living areas

Current Draw: 0.25A at 12V, 0.13A at 24V

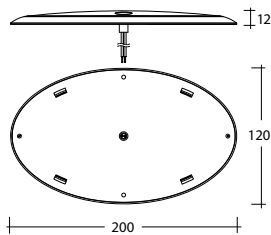
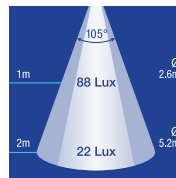
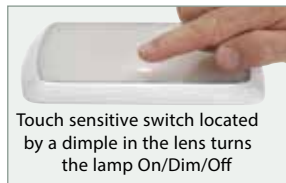

**Part No./ Description**

**306827**

**9-33 Volt Saturn Oval L.E.D Interior lamp with Touch Sensitive On/Dim/Off Switch**

Smooth yet powerful SMD L.E.Ds with a 'Dim' setting and an in-built touch sensitive switch. Elegant oval design complements modern interiors and is surface mountable requiring only a 10mm hole for cable exit

Current Draw: 0.26A at 12V, 0.14A at 24V

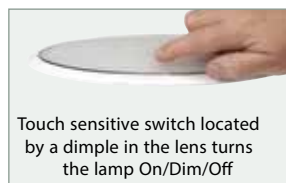
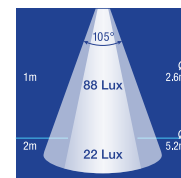

Part No./ Description

**306828**

**9 - 33 Volt Saturn Oval L.E.D Interior lamp with touch sensitive On/dim/Off Switch**



Smooth yet powerful SMD L.E.Ds with a 'Dim' Setting and an in-built touch sensitive switch. A large elegant oval lamp, surface mountable and ideal for illuminating central and living areas.

Current Draw: 0.29A at 12V, 0.14A at 24V

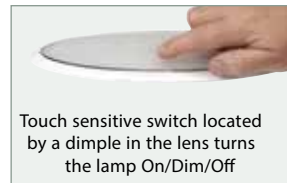
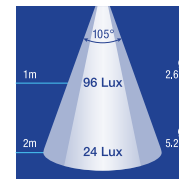
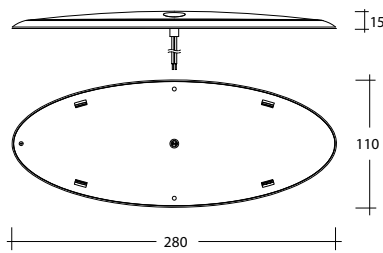

INTERIOR LAMPS



**Part No./ Description**

**306754**  
Interior Dome Light with Off/On Rocker Switch

Bright, wide-angle light output 1 x 21 CP (16W) globe, pre wired and surface mounted

**306755** Lens to suit 306754, 306756

**306754S** As above with Silver Satin Finish

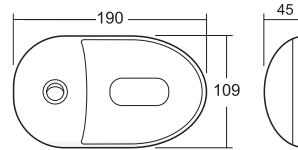

**Part No./ Description**

**306756**  
Dual Interior Dome Light with On/Off Rocker Switch

Bright, wide-angle light output 1 x 21 CP (16W) globe, pre wired and surface mounted

**306755** Lens to suit 306754, 306756

**306756S** As above with Silver Satin Finish

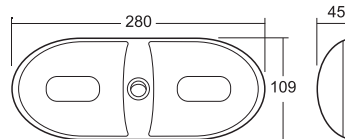



Part No./ Description

**306912**

**10-30 Volt LED Courtesy Lamp with On/Off Switch, White Face Plate and Mounting Spacer**

Features LED output and reliability. Pre-wired and can be flush mounted or surface mounted with the use of the supplied spacer. Switches on and off by pushing the face of the lamp.

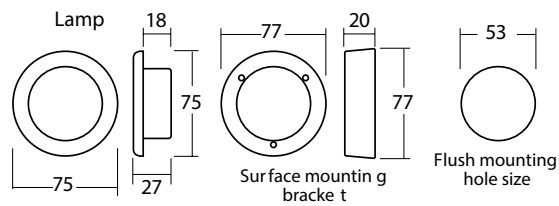

Dimensions: As above



Part No./ Description

**306916**

**10-30 Volt LED Courtesy Lamp with On/Off Switch, and Mounting Spacer**

Features LED output and reliability. Pre-wired and can be flush mounted or surface mounted with the use of the supplied spacer. Switches on and off by pushing the face of the lamp.

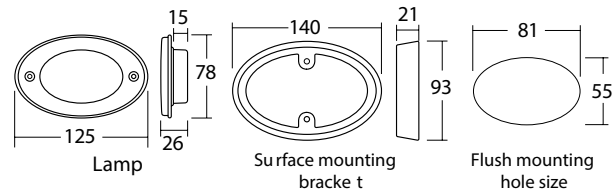

Dimensions: As above

INTERIOR LAMPS

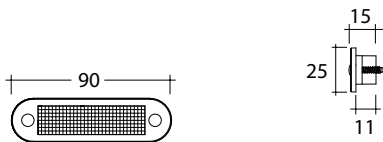

**Part No./ Description**

**306817**

**10-30 Volt LED Courtesy Strip Lamp**

Features LED output and reliability. Pre-wired and sealed in epoxy. Supplied with sealing gasket, self tapping screws and screw caps for an attractive finish.

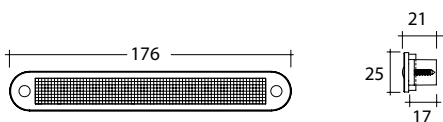

**Part No./ Description**

**306818**

**10-30 Volt LED Courtesy Strip Lamp**

Features LED output and reliability. Pre-wired and sealed in epoxy. Supplied with sealing gasket, self tapping screws and screw caps for an attractive finish.

**Part No./ Description**

**307001**

**10V-30V 1W LED Interior Swivel Lamp with On/Off Switch**

Ultra low current draw of 0.35A makes this lamp perfect for campers, caravans and mobile homes. The powerful 1W LED provides a bright and even spread of light

Allows for easy light adjustment with 350° rotation and 35° tilt



**307001BL** Blister Pack

**307001S**

As above with Silver Satin Finish

**307001SBL** Blister Pack

