

FUSE AND CIRCUIT BREAKER



SMART FUSES
FUSES
FUSIBLE LINKS
FUSE HOLDERS
FUSE BOXES AND BLOCKS
CIRCUIT BREAKER

Smart Fuses improve mean time to repair. Fault finding is now made easy as Smart Fuse illuminate when in a failed state. The internal red L.E.D illuminates when the fuse has overloaded and blow.



Part No.	COMPRISES UNITS	Amps.	VOLTAGE RATING	COLOR CODE
"SMART FUSE" MINI BLADE FUSE L.E.D ASSORTMENTS.				
752110 L.E.D	50	3A	32VDC	VIOLET
752111 L.E.D	50	5A		TAN
752112 L.E.D	50	7.5A		BROWN
752113 L.E.D	50	10A		RED
752114 L.E.D	50	15A		BLUE
752115 L.E.D	50	20A		YELLOW
752116 L.E.D	50	25A		NATURAL
752117 L.E.D	50	30A		GREEN

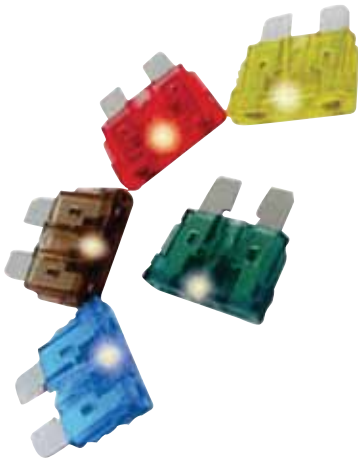

Part No.	COMPRISES UNITS	Amps.	VOLTAGE RATING	COLOR CODE
"SMART FUSE" BLADE FUSE LED ASSORTMENTS.				
752510 LED	50	3A	32VDC	VIOLET
752511 LED	50	5A		TAN
752512 LED	50	7.5A		BROWN
752513 LED	50	10A		RED
752514 LED	50	15A		BLUE
752515 LED	50	20A		YELLOW
752516 LED	50	25A		NATURAL
752517 LED	50	30A		GREEN
752518 LED	50	40A	AMBER	



Part No.	COMPRISES UNITS	Amps.	VOLTAGE RATING	COLOR CODE
"SMART FUSE" MAXI BLADE FUSE LED ASSORTMENTS.				
752710 LED	10	20A	32VDC	VIOLET
752711 LED	10	30A		LT.GREEN
752712 LED	10	40A		ORANGE
752713 LED	10	50A		RED
752714 LED	10	60A		LT.BLUE
752715 LED	10	80A		TRANSPARENT

Glass Fuses.

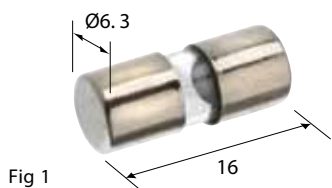

Fig 1

Part No.	Quantity Per box	Amps.	Description	Type	FIG No.
754110	50	3	Internal Soldering Cap	1AG Glass	1

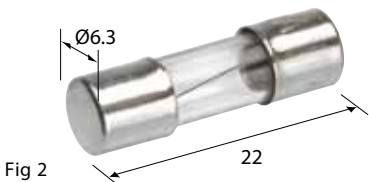

Fig 2

Part No.	Quantity Per box	Amps.	Description	Type	FIG No.
754115	50	3	Internal Soldering Cap	2AG Glass	2
754116	50	3			

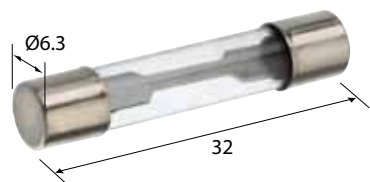

Fig 3

Part No.	Quantity Per box	Amps.	Description	Type	FIG No.
754117	50	1	Internal Soldering Cap	3AG Glass	3
754118	50	2			
754119	50	3			
754120	50	5			
754121	50	7.5			
754122	50	10			
754123	50	15			
754124	50	20			
754125	50	25			
754126	50	30			
754127	50	35			
754128	50	50			
754129	50	14	SFE Glass	4	

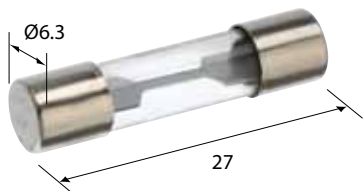

Fig 4

Ceramic Fuses

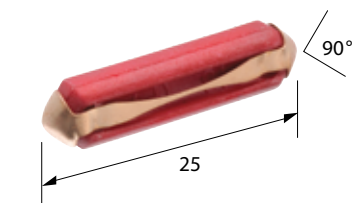
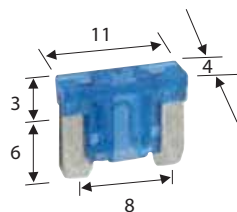

Fig 5

Part No.	Quantity Per box	Amps.	Description	FIG No.
753110	50	5	6AC Ceramic	5
753111	50	8		
753112	50	16		
753113	50	25		



Micro Fuses

Part No.	Blistered Part No.	Quantity Per Box	Amps.	Color Code
752810	752810BL (5)	-	Various	
752811	752811BL (5)	25	5	Orange
752812	752812BL (5)	25	7.5	Brown
752813	752813BL (5)	25	10	Red
752814	752814BL (5)	25	15	Blue
752815	752815BL (5)	25	20	Yellow
752816	752816BL (5)	25	25	White
752817	752817BL (5)	25	30	Green

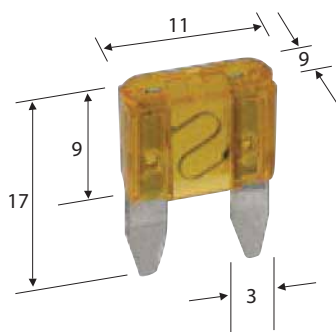

Mini Blade Fuses.

Part No.	Quantity Per Box	Amps.	Color Code
752109	50	2	Grey
752110	50	3	Purple
752111	50	5	Orange
752112	50	7.5	Brown
752113	50	10	Red
752114	50	15	Blue
752115	50	20	Yellow
752116	50	25	White
752117	50	30	Green

Standard ATS Blade Fuses

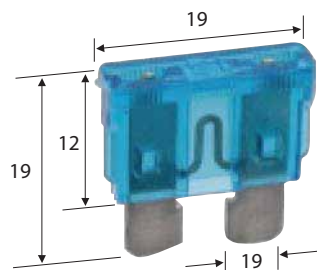

Part No.	Quantity Per Box	Amps.	Color Code
752510	50	3	Purple
752511	50	5	Orange
752512	50	7.5	Brown
752513	50	10	Red
752514	50	15	Blue
752515	50	20	Yellow
752516	50	25	White
752517	50	30	Green
752518	50	40	Brown

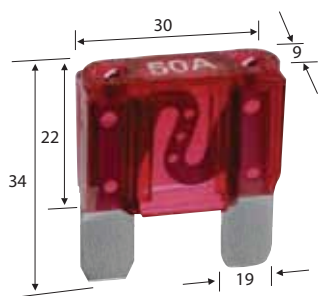

Standard ATS Blade Fuses

Part No.	Quantity Per Box	Amps.	Color Code
752710	10	20	Yellow
752711	10	30	Green
752712	10	40	Orange
752713	10	50	Red
752714	10	60	Light Blue
752715	10	80	White
752716	10	100	Purple

ANL Fuses.

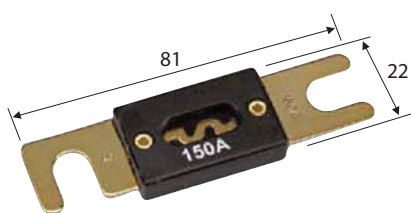

Part No.	Quantity Per Box	Amps.	Type
753029	1	100	Bolt-on fuse. Copper alloy construction with gold plated appearance and inspection window. Ideal for high current applications such as inverters and car audio. Use with Fuse box P/No. 754119
753032	1	100	As Above
753036	1	100	As Above

Fuses Links - Female



Part No.	Quantity Per Box	Amps.	Color Code
755110	10	20	White
755111	10	30	Pink
755112	10	40	Green
755113	10	50	Red
755114	10	60	Yellow
755115	10	70	Brown
755116	10	80	Black
755117	10	100	Dark Blue

Fuses Links - Male

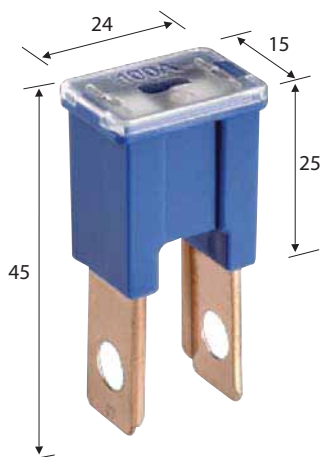

Part No.	Quantity Per Box	Amps.	Color code
755120	10	20	White
755121	10	30	Pink
755122	10	40	Green
755123	10	50	Red
755124	10	60	Yellow
755125	10	70	Brown
755126	10	80	Black
755127	10	100	Dark Blue
755128	10	120	Grey



Female Plug In With Lock

Part No.	Quantity Per Box	Amps.	Color Code
755140	10	45	Red
755141	10	65	Black
755142	10	75	Grey

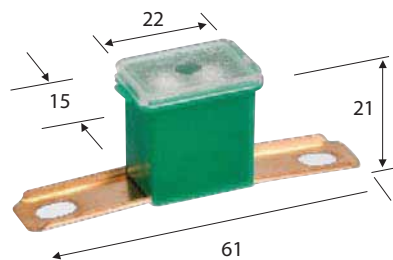

L Type (61mm)

Part No.	Quantity Per Box	Amps.	Color Code
755132	10	40	Green
755133	10	50	Red
755134	10	60	Yellow
755135	10	70	Brown
755136	10	80	Black
755137	10	100	Blue



Mini Female Type 1

Part No.	Quantity Per Box	Amps.	Color Code
755150	10	20	Light Blue
755151	10	30	Pink
755152	10	40	Green
755153	10	50	Red
755154	10	60	Yellow
755155	10	80	Black
755156	10	100	Blue



Mini Female Type 2

Part No.	Quantity Per Box	Amps.	Color Code
755170	10	20	[Light Blue]
755171	10	30	[Pink]
755172	10	40	[Green]
755173	10	50	[Red]
755174	10	60	[Yellow]
755176	10	80	[Black]
755177	10	100	[Dark Blue]



Mini Female Twith Lock

Part No.	Quantity Per Box	Amps.	Color Code
755160	10	25	[Brown]
755161	10	30	[Green]

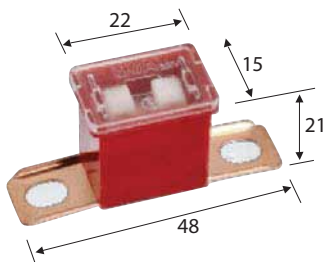

Fuse Link - Plug In

Part No.	Quantity Per Box	Amps.	Color Code
755230	10	20	[Light Blue]
755231	10	30	[Pink]
755232	10	40	[Green]
755233	10	50	[Red]
755234	10	60	[Yellow]
755235	10	70	[Brown]
755236	10	80	[Black]
755237	10	100	[Dark Blue]



Part No./ Description

757010BL Blister Pack

In-Line Glass Fuse Holder with 10 Amp Fuse (P/No. 754112)

Amperage rating 10A

757010/50 As above Bulk Pack of 50, fuses not included



Part No./ Description

757011BL Blister Pack

In-Line Glass Fuse Holder with 30 Amp Fuse (P/No. 754126)

Amperage rating 30A

Bakelite construction

757011/50 As above Bulk Pack of 50, fuses not included



Part No./ Description

757012BL Blister Pack

Panel Mount Glass Fuse Holder with Solder Type Terminals and 10 Amp Fuse (P/No. 754122)

Amperage rating 30A

Mounting opening 15mm dia.

757012/50 As above Bulk Pack of 50, fuses not included



Part No./ Description

757013BL Blister Pack

Panel Mount Glass Fuse Holder with Push On Terminals and 10 Amp Fuse (P/No. 754122)

Amperage rating 10A

Mounting opening 15mm dia.

757013/50 As above Bulk Pack of 50, fuses not included



Part No./ Description

757014BL Blister Pack

'Clip-Lock' In-Line Ceramic Fuse Holder with 8 Amp Ceramic Fuse (P/No. 754111)

Amperage rating 25A

757014/25 As above Bulk Pack of 25



Part No./ Description
757020BL Blister Pack
In-Line Waterproof Glass Fuse Holder
 Supplied with crimp terminals
 Amperage rating 30A
757020/10 As above Bulk Pack of 10

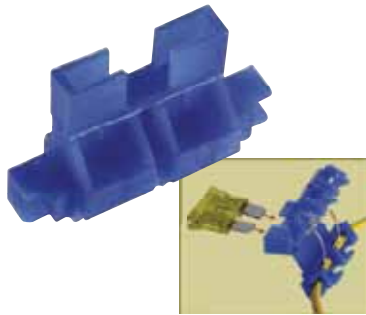

Part No./ Description
757021BL Blister Pack
'Quick Connect' In-Line Standard ATS Blade Fuse Holder
 Amperage rating 20A
757021/50 As above Bulk Pack of 50



Part No./ Description
757022BL Blister Pack
In-line Standard ATS Blade Fuse Holder for use with Female 6.3mm Blade Terminal
 Can be interlocked face to face
 Amperage rating 30A
757022/50 As above Bulk Pack of 50



Part No./ Description
757023BL Blister Pack
In-Line Standard ATS Blade Fuse Holder
 Amperage rating 30A
757023/50 As above Bulk Pack of 50



Part No./ Description
757024BL Blister Pack
In-Line Standard ATS Blade Fuse Holder
 Amperage rating 30A
757024/50 As above Bulk Pack of 50

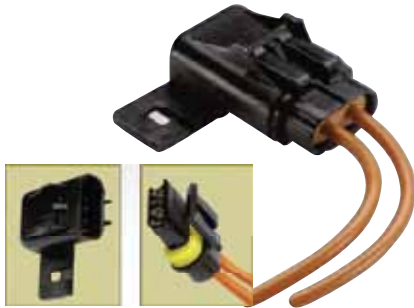

Part No. / DESCRIPTION

757025BL Blister Pack
**In-Line Waterproof Standard
 ATS Blade Fuse Holder**

Amperage rating 30A

757025/10 As above Bulk Pack of 10



Part No./ Description

757026BL Blister Pack
**In-Line Standard ATS Blade Fuse Holder
 with Weatherproof Cap**

Amperage rating 30A

757026/10 As above Bulk Pack of 10



Part No./ Description

757027BL Blister Pack
**In-Line Mini Blade Fuse Holder
 with Weatherproof Cap**

Amperage rating 30A

757027/10 As above Bulk Pack of 10



Part No./ Description

757028
**In-Line Maxi Blade Fuse Holder
 with Weatherproof Cap**

Amperage rating 60A

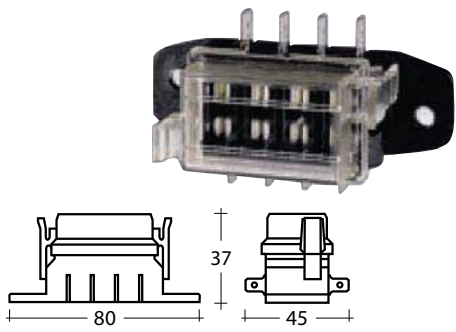

Part No./ Description
757029BL Blister Pack
4-Way Standard ATS Blade Fuse Box with Transparent Cover, Gasket and 8 Terminals

Suitable for lateral connection with female 6.3mm blade terminal. Amperage rating 30A per circuit at 12V.
 Dimensions : 80 x 45 x 37 mm

757029/10 As above Bulk Pack of 10

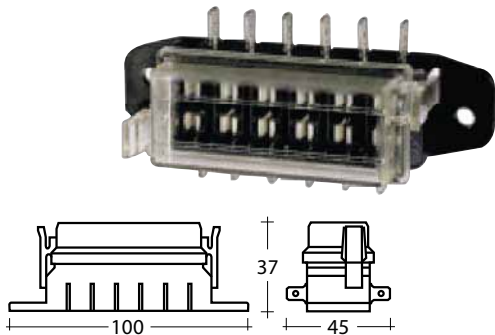

Part No./ Description
757030BL Blister Pack
6-Way Standard ATS Blade Fuse Box with Transparent Cover, Gasket and 12 Terminals

Suitable for lateral connection with female 6.3mm blade terminal. Amperage rating 30A per circuit at 12V.
 Dimensions : 100 x 45 x 37 mm

757030/10 As above Bulk Pack of 10

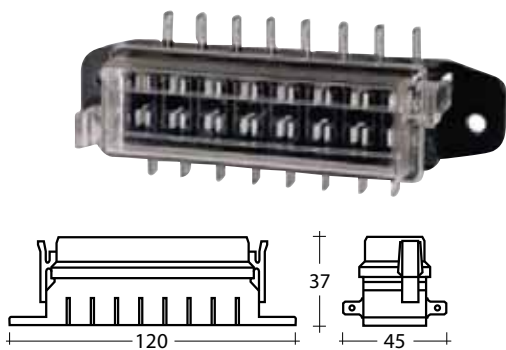

Part No./ Description
757031BL Blister Pack
8-Way Standard ATS Blade Fuse Box with Transparent Cover, Gasket and 16 Terminals

Suitable for lateral connection with female 6.3mm blade terminal. Amperage rating 30A per circuit at 12V.
 Dimensions : 120 x 45 x 37 mm

757031/10 As above Bulk Pack of 10

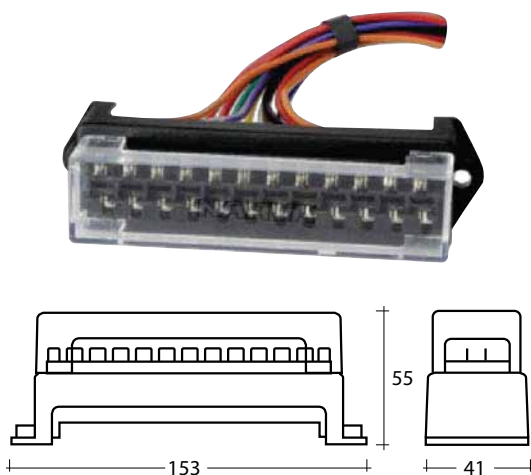

Part No./ Description
757035 Blister Pack
12-Way Pre-Wired Standard ATS Blade Fuse Box with Transparent Cover, Two Power Inputs

Pre-wired with 300mm of cable
 Amperage rating 30A per circuit at 12V
 40A max per input lead and 80A max per box
 Dimensions: 153 x 54 x 41mm





Part No./ Description

757032
6 Way Standard ATS Blade Fuse or Plug-in Type
Circuit Breaker Block with Single Power In Terminal

Amperage rating 25A per circuit 12V 150A max per block.

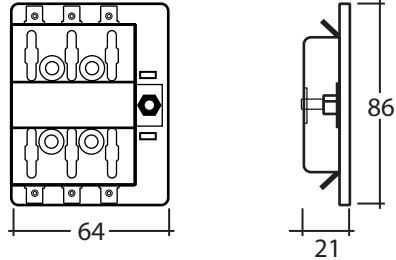

Part No./ Description

757033
8 Way Standard ATS Blade Fuse or Plug-in Type
Circuit Breaker Block with Single Power In Terminal

Amperage rating 25A per circuit 12V 150A max per block.

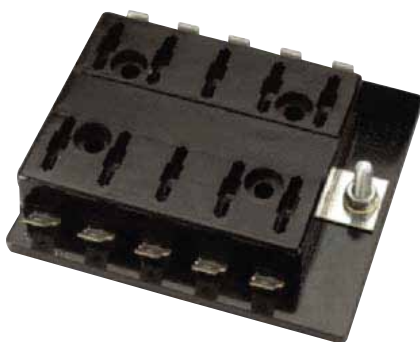
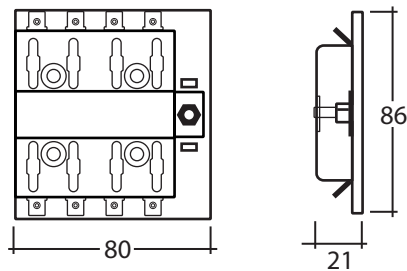

Part No./ Description

757034
10 Way Standard ATS Blade Fuse or Plug-in Type
Circuit Breaker Block with Single Power In Terminal

Amperage rating 25A per circuit 12V 150A max per block.

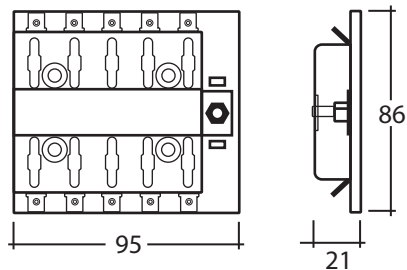

Circuit Breakers - Automatic Reset

Metal Circuit Breaker Automatic Reset (Type I) with 90° Bracket
Voltage : 6-24, Operating Temperature: -23°C to 65°C

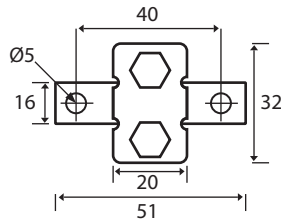
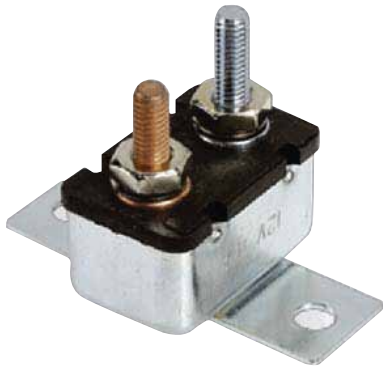

Part No.	Quantity Per Box.	Amps.
756110	1	10
756111	1	15
756112	1	20
756113	1	25
756114	1	30
756115	1	35
756116	1	40
756117	1	50

Plastic Automatic

Plastic Circuit Breaker/ Automatic Reset (Type 1) with Straight Bracket, Voltage : 6-24, Operating Temperature: -23°C to 65°C

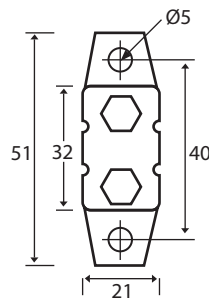

Part No.	Quantity Per Box.	Amps.
756118	1	10
756119	1	15
756120	1	20
756121	1	30
756122	1	40
756124	1	50



Part No./ Description

756129

High Amp Circuit Breaker

High Amp Circuit Breaker Automatic Reset (Type I)

Surface mount sealed for engine compartment or marine applications

Voltage : 12 - 42V
 Operating Temperature : -32°C to 82°C

Part No.	Quantity Per Box.	Amps.
756129	1	60
756130	1	80
756131	1	100
756132	1	120
756133	1	150



Part No./ Description

756315

CDM : Sealed Construction, Manual Reset, 10Amps

c-c mounts : 40mm
 Mount hole diameter : 11mm
 Width : 51.5 mm
 Height : 23mm

Part No.	Amps.
756316	12.5
756317	15
756318	17.5
756319	20
756320	30
756321	35
756322	40

Part No./ Description

756323**CDM : Sealed Construction, Manual Reset, 35Amps**

c-c mounts : 61.5mm
 Terminal Diameter : 6mm studs
 Mount hole diameter : 19.5mm
 Width : 73 mm
 Height : 26.5mm

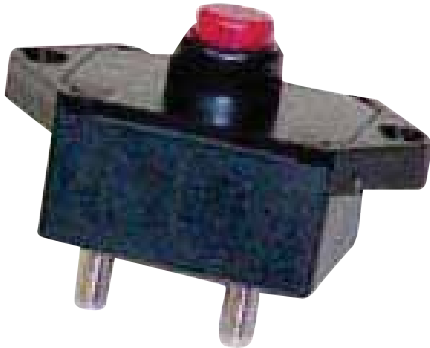

Part No.	Quantity Per Box.	Amps.
756324	1	40
756325	1	45
756326	1	50
756327	1	60
756328	1	70
756329	1	80
756330	1	90
756331	1	105
756332	1	120
756333	1	135
756334	1	150

Part No./ Description

756335**Manual & Switchable Reset Reset Circuit Breakers**

Ratings : 60A to 200A; 30VDC, 3000 Amp
 Interrupt Capacity

Operating Temperature : -30 °C to 82 °C

Storage Temperature : -34 °C to 149 °C

Applications : Typically used in auxillary and accessory circuit-truck, buses, Rv's and marine applications. Other might include Battery Chargers and DC audio systems.

Testing : Complies with SAE J1625

Housing : Thermoset plastic; UL rated 94VO; 155°C
 Stud insulators are provided on covered units with F (Surface Mount) bases.

Mounting : Panel or surface



Part No.	Quantity Per Box	Amps.
756336	1	70
756337	1	80
756338	1	100
756339	1	120
756340	1	140
756341	1	150
756342	1	180
756343	1	200



Part No./ Description

756347

High Amp Circuit Breakers

High Amp Circuit Breaker Manual Reset (Type III)

Surface mount sealed for engine compartment or marine applications with unique reset mechanism providing visible indication of tripped circuit

Voltage : 12 - 24 VDC

Operating Temperature : -32°C to 82°C

Part No.	Quantity Per Box.	Amps.
756347	1	60
756348	1	80
756349	1	100
756350	1	120
756351	1	150